

Features:

- ◆ Frequency Range: 5 to 1000 MHz
- ◆ Transmission loss: 1.30dB Max, Nominal Coupling: 16.0dB Typ
- ◆ Surface mount and available in tape and reel
- ◆ 260°C reflow compatible
- ◆ RoHS Compliant and Pb free
- ◆ Operating temperature range: -40°C to +85°C
- ◆ Storage temperature range: -55°C to +100°C



Applications:

- ◆ For catv
- ◆ For broadband and wireless communications

Dimension diagram (Unit:mm) :

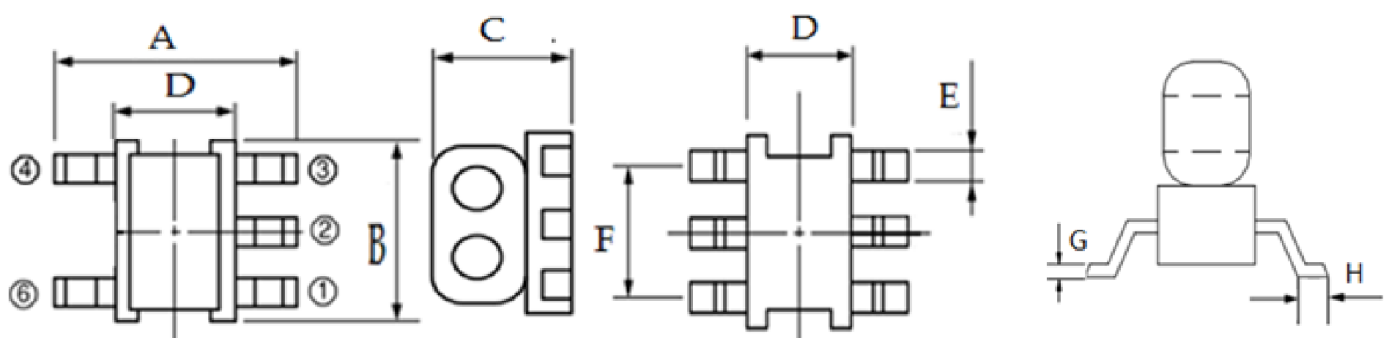

A=5.30±0.20 B=4.30±0.20 C=3.50±0.20 D=2.80±0.20 E=0.55±0.05 F=3.00±0.05 G=0.25±0.05 H=0.60±0.05

Electrical structure:

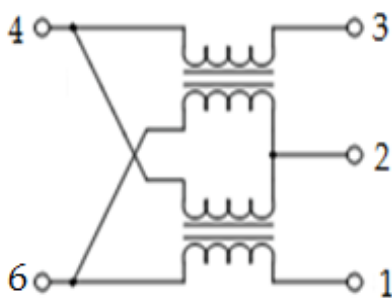

Recommended layout:

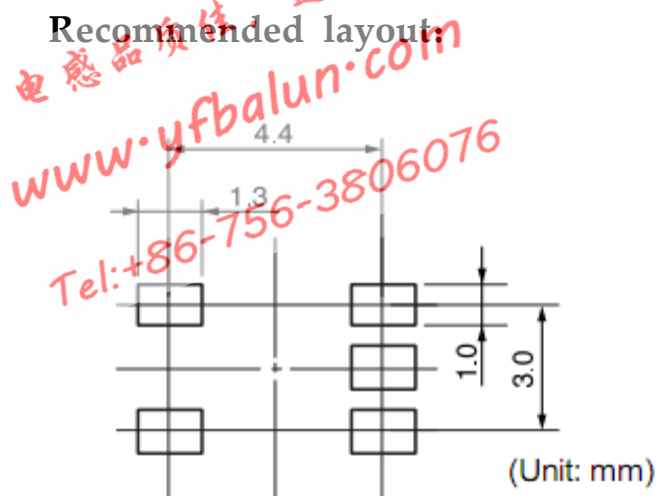

DRAW BY

yang lin

CHECKED BY

ye yong jun

APPROVED BY

deng gao

Mainline Loss & Coupling Test Curve :



Pin Out

Pin	Function
1	Main Line Input
2	Ground
3	Coupled Output
4	Terminated
5	Main Line Output

“电感品质佳，选粤发”
www.yfbalun.com
Tel:+86-756-3806076

Insertion Loss:

Coupling :

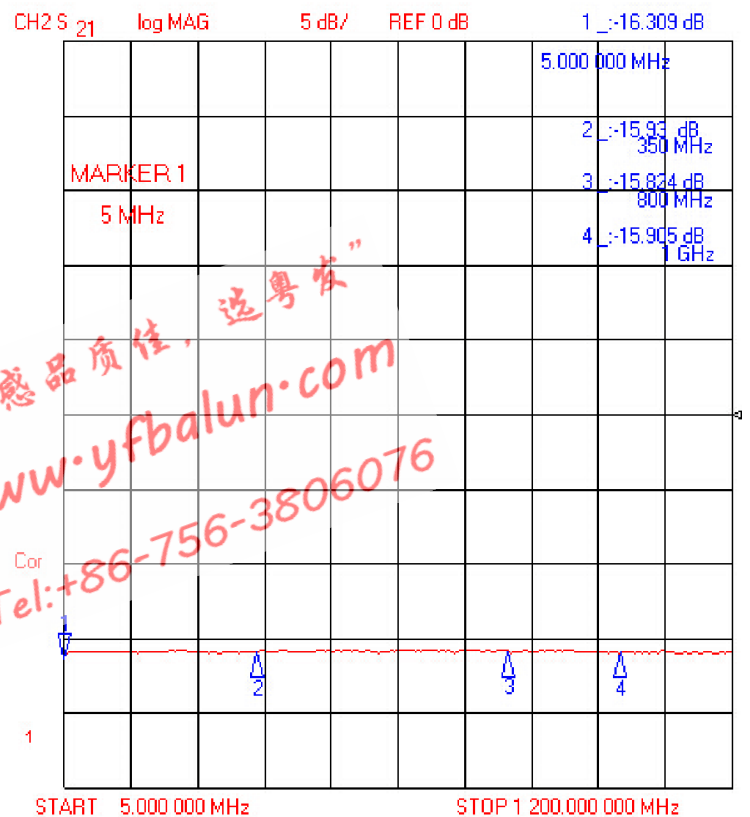
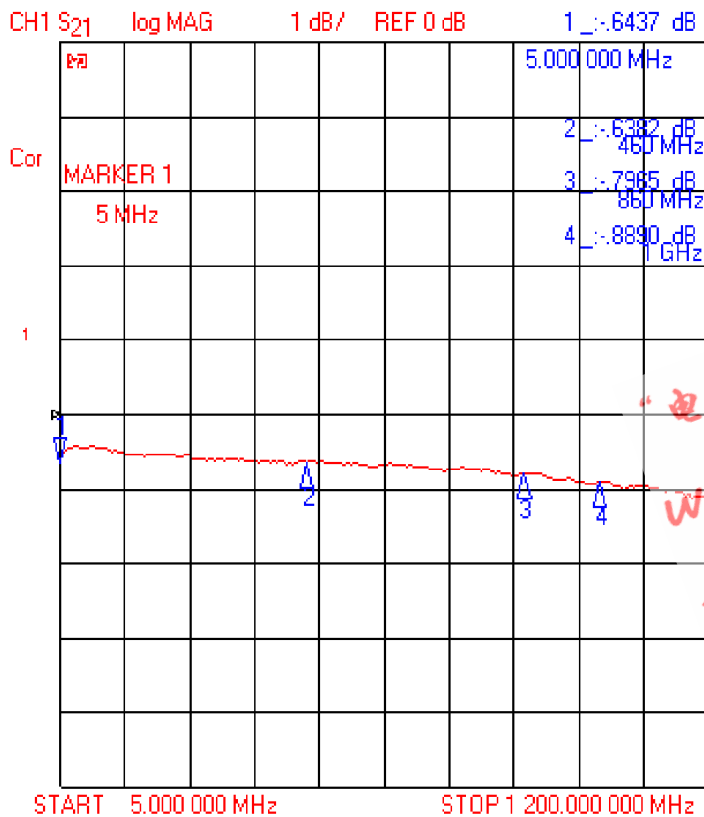

“电感品质佳，选粤发”
www.yfbalun.com
Tel:+86-756-3806076

DRAW BY

yang lin

CHECKED BY

ye yong jun

APPROVED BY

deng gao

Return Loss Test Curve:



Input Reflection (dB)

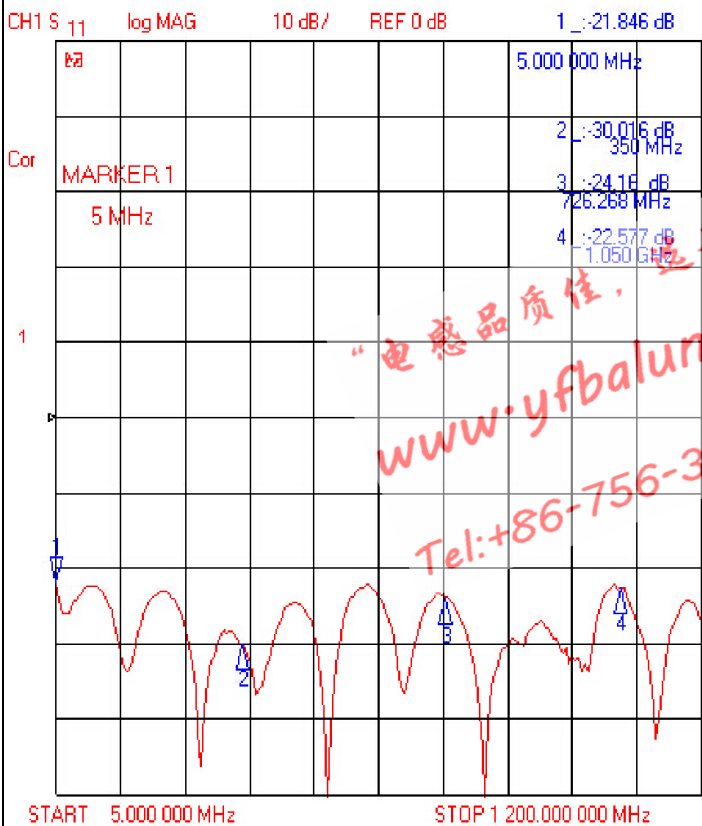

Output Reflection (dB)

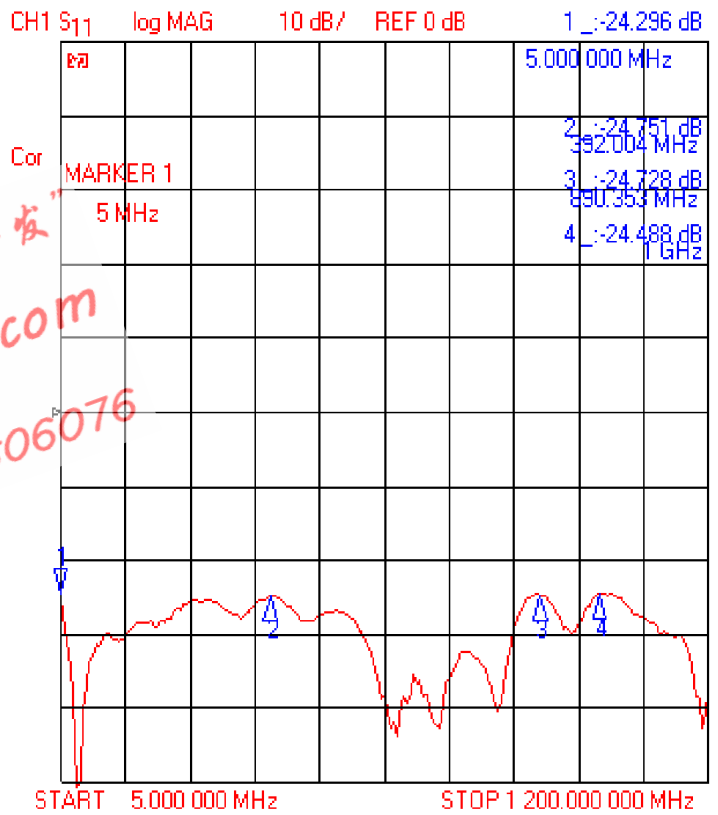

couping Reflection (dB)

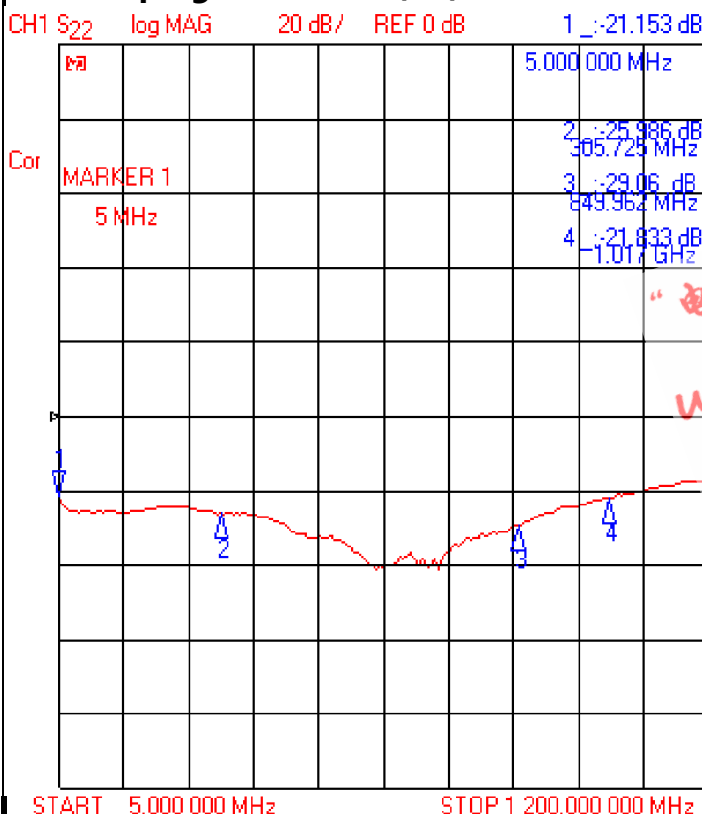

Isolation (dB)

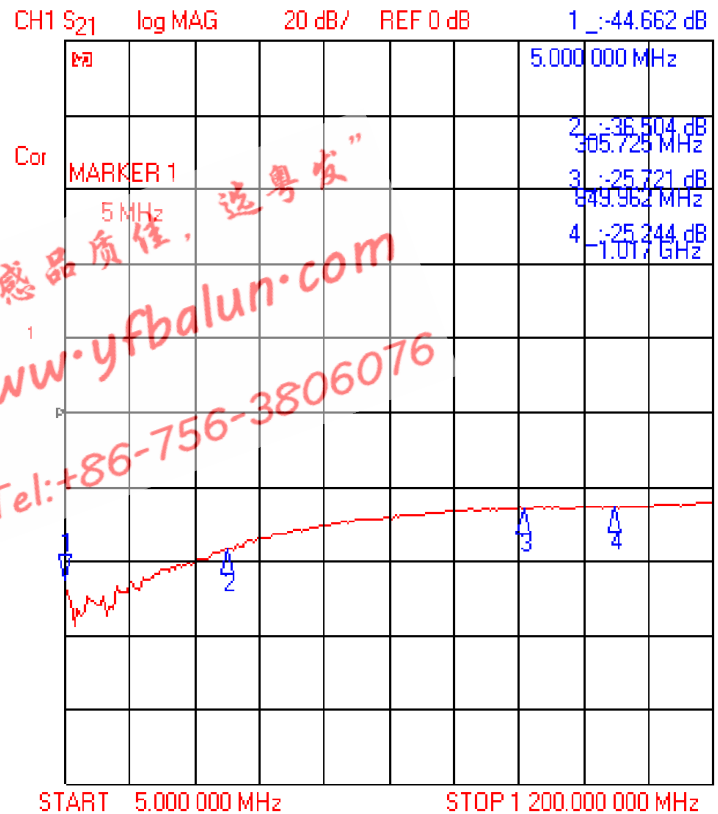

“电感品质佳，选粤发”
www.yfbalun.com
Tel:+86-756-3806076

“电感品质佳，选粤发”
www.yfbalun.com
Tel:+86-756-3806076

DRAW BY

yang lin

CHECKED BY

ye yong jun

APPROVED BY

deng gao

Recommended Soldering Temperature Graph:

建议迴焊条件
The condition of reflow
(Recommendation)

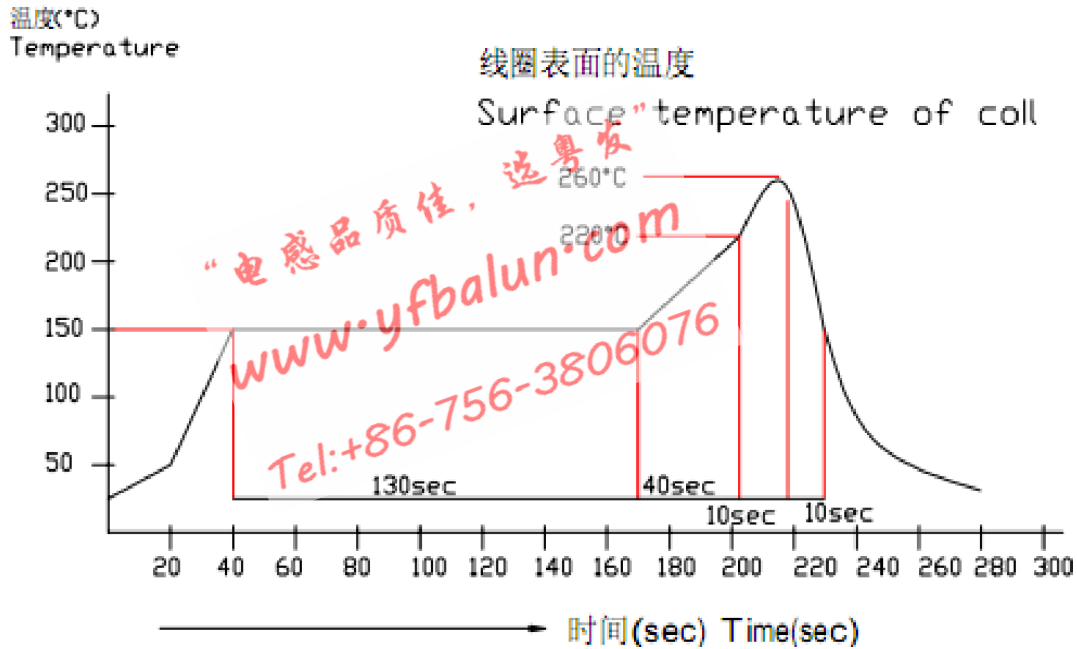

Packging Dimension For Carrier Tape(UNIT:mm):

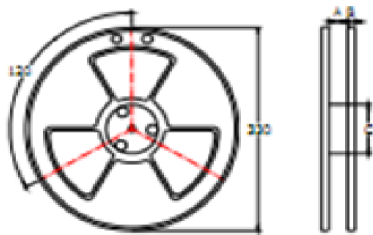
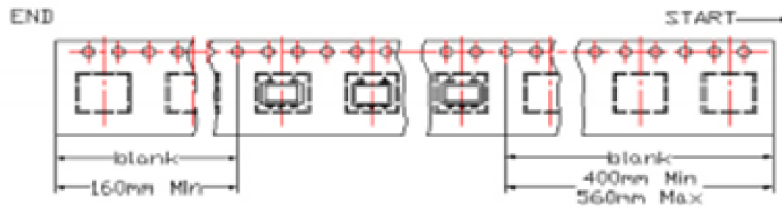

SPEC	8	12	16	24	32	44	56	72
DIM A±0.1	8.5	12.5	16.5	24.5	32.5	44.5	56.5	72.5
DIM B±0.1	2.5	2.3	2.3	2.3	2.3	2.3	2.3	2.3
DIM Ct±0.1	100	100	100	100	100	100	100	100

“电感品质佳，选粤发”
www.yfbalun.com
Tel:+86-756-3806076

QUANTITY

2000PCS/Reel

DRAW BY

yang lin

CHECKED BY

ye yong jun

APPROVED BY

deng gao